



# SPOT SMART THERMOSTAT

## INSTALLATION, USE

Wi-Fi SPOT Thermoregulator starter kit

Wi-Fi SPOT Thermoregulator expansion kit



CE

EN

Translation of the original instructions (in Italian)

Thank You for choosing and buying one of our products. Please read these instructions carefully in order to properly install, operate, and maintain the product.



**WARNING:** this instruction manual is an integral and essential part of the product. It shall be supplied by the installer to the user who shall keep it carefully to consult it whenever necessary. This document shall be supplied together with the equipment in case the latter is sold or transferred to others. Use for purposes other than those specified in this manual is not permitted. All installation or maintenance operations must be carried out by qualified personnel. The manufacturer cannot be held responsible for any damage to persons, animals and/or property caused by improper use of the product or failure to comply with these instructions. The manufacturer reserves the right to modify the products and/or its components as deemed necessary, in any moment and without prior notice.



**DANGER:** during cleaning, maintenance, electrical connection operations it is mandatory to disconnect the gateway and boiler from the power supply.



**DANGER:** do not carry out operations that involve removing the appliance from its installation.



**DANGER:** do not use the appliance for purposes other than for domestic use or similar.



**DANGER:** do not use insecticides, solvents or aggressive detergents to clean the appliance.



**WARNING (applies to Thermostat only):** the appliance may be used by children of at least 8 years of age and by persons with reduced physical, sensory or mental capabilities or lack of the necessary knowledge, provided that they are under supervision or have been instructed in the use of the appliance. Children may not play with the appliance and/or clean the appliance unless they have been properly instructed beforehand.



**WARNING (APPLIANCE DISPOSAL):** once the electronic appliance comes to the end of its life, it must be disposed of in compliance with the regulations in force (WEEE waste from electrical and electronic equipment) and in respect of the environment. If in doubt, contact the appliance manufacturer's representative in your country.

The product complies with the essential requirements of the following European Directives and Regulations:

- RED DIRECTIVE 2014/53/EU
- ROHS DIRECTIVE 2011/65/EU
- DELEGATED REGULATION (EU) No. 811/2013
  
- **Wi-Fi SPOT Thermoregulator starter kit:** it consists of a thermostat and a gateway which, paired together, can manage a heating zone.
- **Wi-Fi SPOT Thermoregulator expansion kit:** it consists of a thermostat and a Sonoff Wi-Fi relay to manage an additional heating zone.

The Wi-Fi SPOT Thermoregulator expansion kit must be added to the Wi-Fi SPOT Thermoregulator starter kit in order to manage additional heating zones. It is possible to manage up to three heating zones.

### THERMOSTAT CHARACTERISTICS

Dimensions:	diameter: 70mm, thickness 35mm
Colour:	White, with coloured rubber rings
Wireless technology:	Bluetooth 4.1 BLE
Distance between thermostat and Gateway:	Maximum 15 m (30 m in open space)
Reading range:	0°C to 40°C
Reading accuracy:	+/- 0.1 K
Setting range:	5°C to 30°C
Temperature increase range:	0.5 K
Power supply:	No. 2 1.5 V AAA batteries (not rechargeable) mod.LR03 Battery duration approx. 2 years*
Fastening:	screws and plugs on bracket with integrated level

\* duration calculated with normal use, with use at ambient temperature from 16°C to 27°C

**GATEWAY / RADIO RELAY CHARACTERISTICS**

Power supply	230Vac + 10%-15%
Frequency	50/60Hz
Relay dry contact (gateway relay only)	230Vac 0.5A cos phi 1max
Relay live contact (radio relay only)	230Vac 10A cos phi 1max
Communication with boiler (gateway only)	wired bus
Wi-Fi radio communication	802.11 b/g/n (2.4Ghz)
Bluetooth radio communication	4.1 BLE
Operating ambient temperature	0 ÷ +40 °C
Storage ambient temperature	-10 ÷ +50 °C

**PRODUCT DATA SHEET**

Name of the supplier	FONDITAL
Identification model of the supplier	SPOT SMART THERMOSTAT
Temperature control class	V
% of contribution to energy efficiency for space heating	+3%
<b>By adding an external probe:</b>	
Temperature control class	VI
% of contribution to energy efficiency for space heating	+4%
<b>In a system of 3 zones with 3 sensors (1 starter kit + 2 expansion kits):</b>	
Temperature control class	VIII
% of contribution to energy efficiency for space heating	+5%

# THERMOSTAT INSTRUCTIONS

## Thermostat description

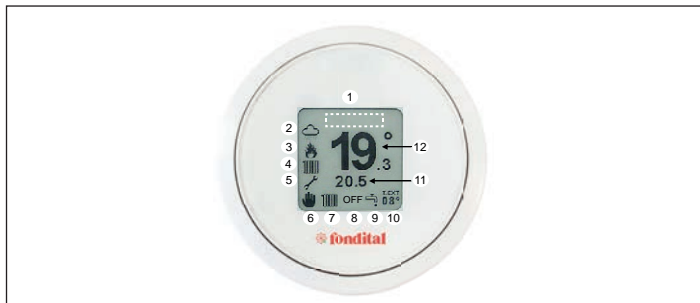

KEY:		
1	-	failure display area
2	-	weather
3	-	burner status: on/off
4		heating request in progress
4		DHW request in progress
5		technical support enabling
5		battery 100%
5		battery 75%
5		battery 50%

KEY:		
5		battery 25%
5		low battery
6		progr. thermostat in manual mode
6		progr. thermostat active
6		progr. thermostat partially active
7-9		winter
7-9		summer
8	-	OFF
11	-	set temperature
12	-	ambient temperature

Navigation gestures:

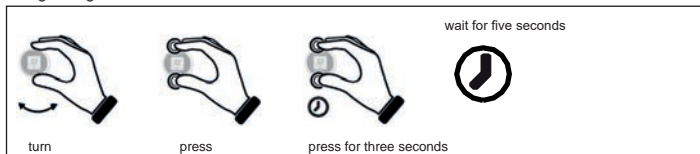

Set temperature

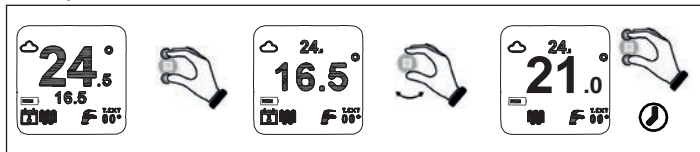

Set programmable thermostat function

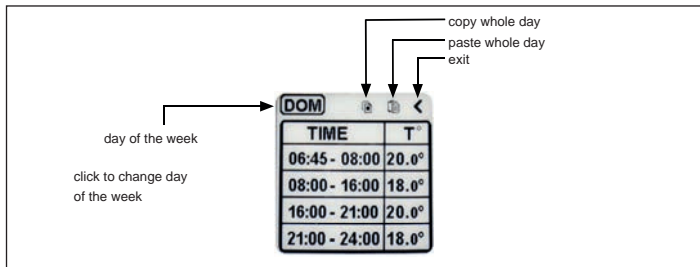





How to select and set the time:



How to select and set the temperature:



## Navigation through the menus

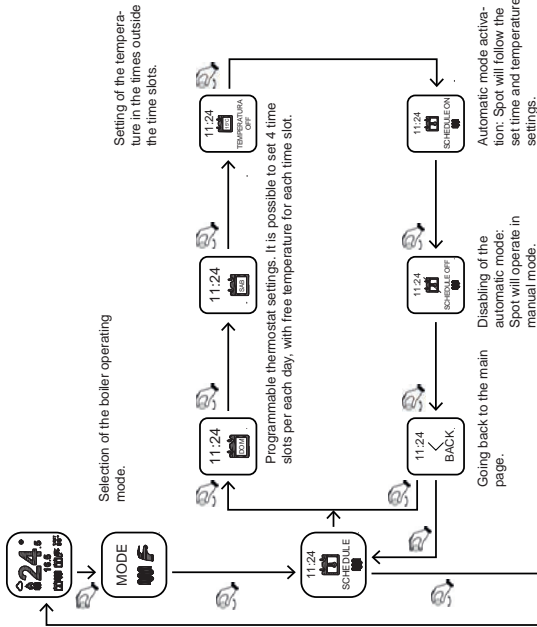



SETTING



11:24  
DATA & TIME

Date and  
time setting.



11:24  
LANGUAGE

Language  
set-up.



11:24  
THERMOSTAT

Boiler thermore-  
gulation setting.

Domestic hot  
water settings.

Area relay delay  
setting.



DIAGNOSTIC

Display of:

- Mac address
  - Bluetooth signal quality
  - Connection status
  - Battery level
- Press here to pair the  
Spot with the gateway.



BACK

Going back to the main page.



11:24  
BACK

## Operating mode

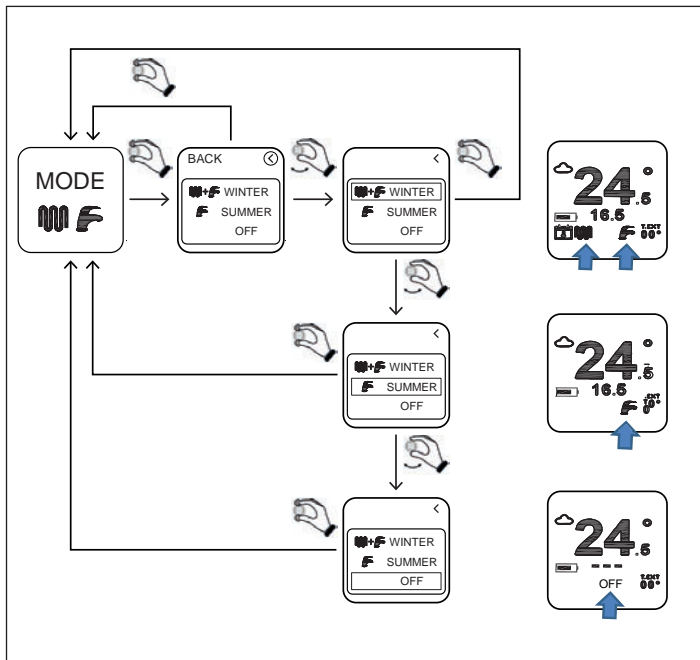

**WINTER:** the boiler is enabled to produce both hot water for heating and domestic hot water.

**SUMMER:** the boiler is enabled to produce domestic hot water only. Heating is disabled.

**OFF:** each boiler operation request is disabled. Antifreeze function is guaranteed.



**MIN:** is the minimum temperature of the heating water that the boiler will provide in modulating operation

(regulation type=room temp /external temp/ room-external).

**MAX:** is the maximum temperature of the heating water that the boiler will provide in modulating operation

(regulation type=room temp /external temp/ room-external).

**MAX:** is the maximum temperature of the heating water that the boiler will provide in static operation

(regulation type=on/off).

## DHW temperature setting

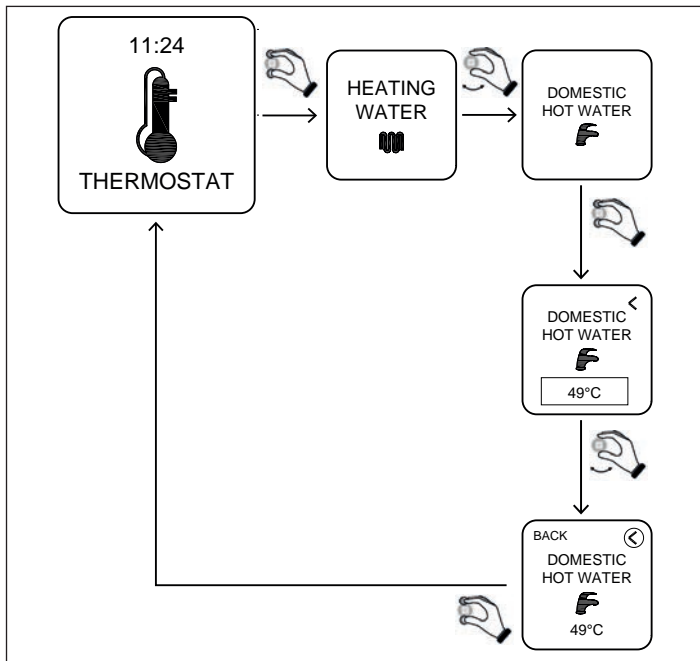



**DOMESTIC HOT WATER:** the boiler will produce domestic hot water at the temperature set with this parameter.

## Setting of differential - antifreeze temperature - probe correction

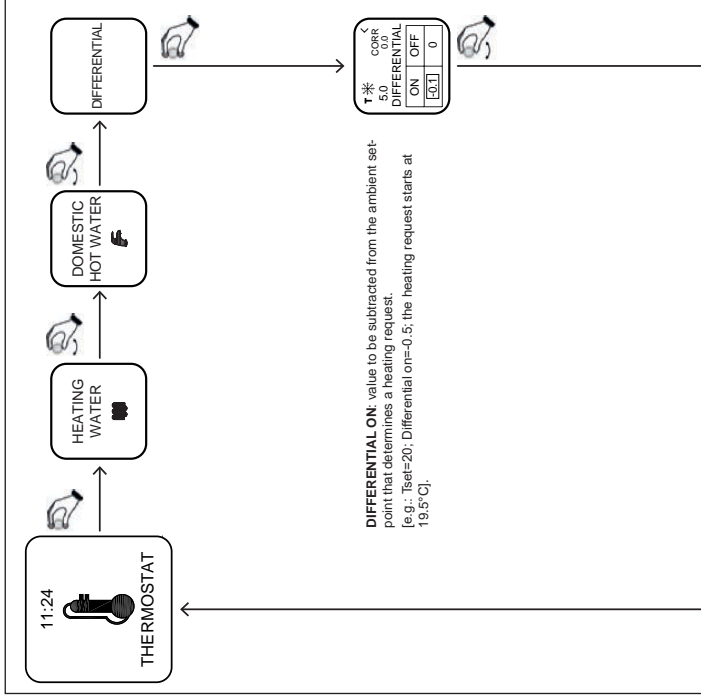

**DIFFERENTIAL OFF:** value to be added to the ambient set-point that determines the end of heating.  
[e.g.: Tset=20; Differential off=+0.5; the heating request stops at 20.5°C].



T*	CORR
5.0	0.0
DIFFERENTIAL	
ON	OFF
-0.1	0

**CORR:** ambient probe correction. Value to add / subtract to offset any error.



T*	CORR
5.0	0.0
DIFFERENTIAL	
ON	OFF
-0.1	0

**Antifreeze:** is the ambient temperature under which an antifreeze request is triggered regardless of the operating mode.

## Setting the type of regulation of hot water for heating



HEATING  
WATER

DOMESTIC  
HOT WATER

DIFFERENTIAL

REGULATION  
TYPE



**ON-OFF:** the temperature of hot water for heating is fixed and equal to the MAX value set in the "HEATING WATER" menu.



**ROOM:** the temperature of the hot water for heating varies (within MAX - MIN values) depending on the ambient temperature. This guarantees lower gas consumption compared to a traditional thermostat system and an excellent comfort (recommended).



**EXTERNAL:** the temperature of the hot water for heating varies (within MAX - MIN values) depending on the external **temperature**. This guarantees lower gas consumption compared to a traditional thermostat system.



**ROOM + EXTERNAL:** the temperature of the hot water for heating varies (within MAX - MIN values) depending on the external temperature and the ambient temperature.



**Setting the regulation curve of hot water for heating  
(to be made by the installer)**

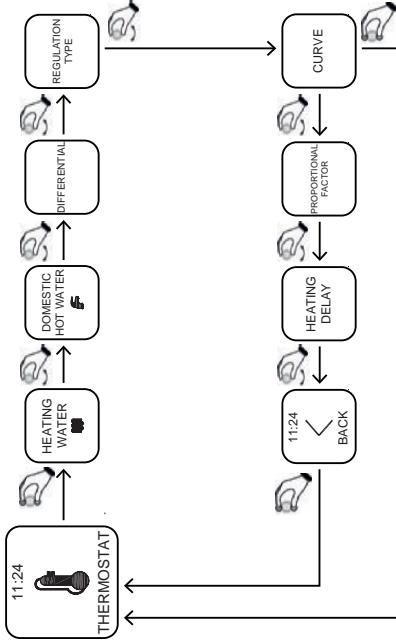

**CURVE:** this parameter affects the relation between external temperature and heating water temperature. The range goes from 0 to 3. The higher the value, the greater the influence of the external temperature. Values between 0.1 and 0.9 are values for floor systems. Values between 1 and 3 are values for radiator systems. Usually, it is possible to set curves=0.6 for floor systems and curves=1.5 for radiator systems.

Value 0 must be set in particular installations (see Gateway manual).



## Proportional factor setting (by the installer)

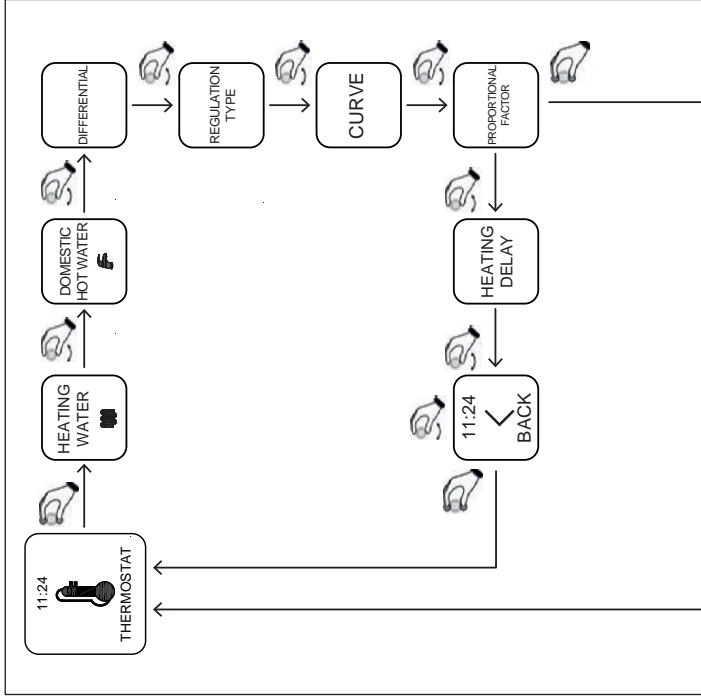



**PROPORTIONAL FACTOR:** this parameter affects the relation between external/ambient temperature and heating water temperature. The range goes from 0 to 20. The higher the value, the greater the influence of the external/ambient temperature. Recommended value: 8.



## Heating delay setting (by the installer)

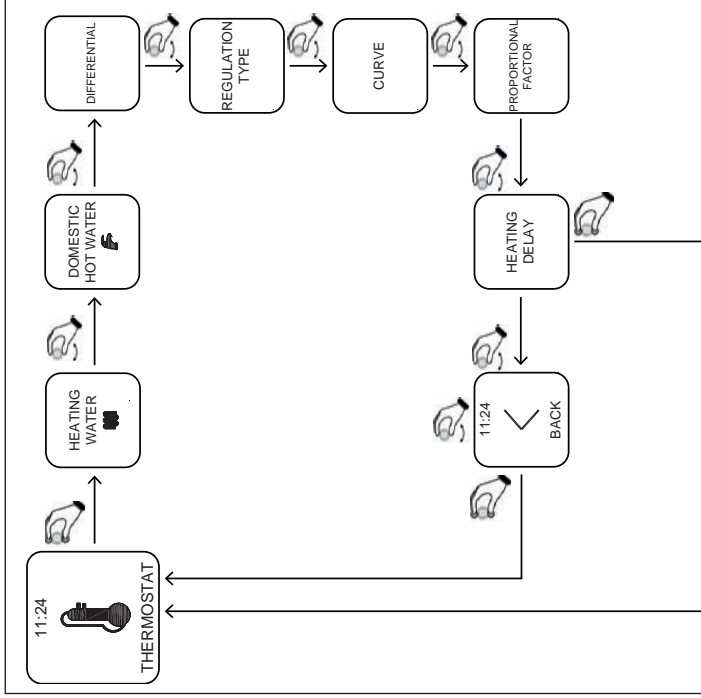

**HEATING DELAY:** with this parameter you delay the boiler ignition to allow the zone valves to open. At the end of a heating request, it is the zone valve that closes late to ensure correct post-circulation to the boiler pump.



The installer is asked to check the opening time in the characteristics of the valve and to set the Heating delay to the same value (do not set below 30 seconds).



## **App – Webapp**

The programmable thermostat can also be managed remotely through the MYSPOT app downloadable from Google play store and Apple store. For installation and registration procedures, please refer to the installation instructions of the gateway.

Once the app has been downloaded, the programmable thermostat can also be reached from the main browsers through the Webapp accessible from the Fondital website.

## **Technical support enabling**

From the “settings” page, the user can enable or disable the remote control of the boiler and heating system by the Fondital technical support.

## **Replace the battery**

When the battery level is as in figure , it means that the battery must be replaced\*. Use two 1.5V AAA batteries (not rechargeable) mod.LR03.

\* actually the thermostat will continue to work but the messages displayed could be illegible, it is recommended to replace the battery as soon as the display shows the low battery icon.

## How to replace the battery

Disconnect the thermostat from the wall bracket and replace the battery respecting the polarities:



**WARNING:** when changing the battery or turning it on for the first time, remember to set the correct date and time.



**WARNING:** the batteries can be replaced only by the user. The manufacturer cannot be held responsible for any damage to persons, animals and/or property caused by improper use of the product or failure to comply with these instructions.



**DANGER:** risk of explosion if the batteries used are not of the correct type.

## GATEWAY INSTRUCTIONS

### Gateway description

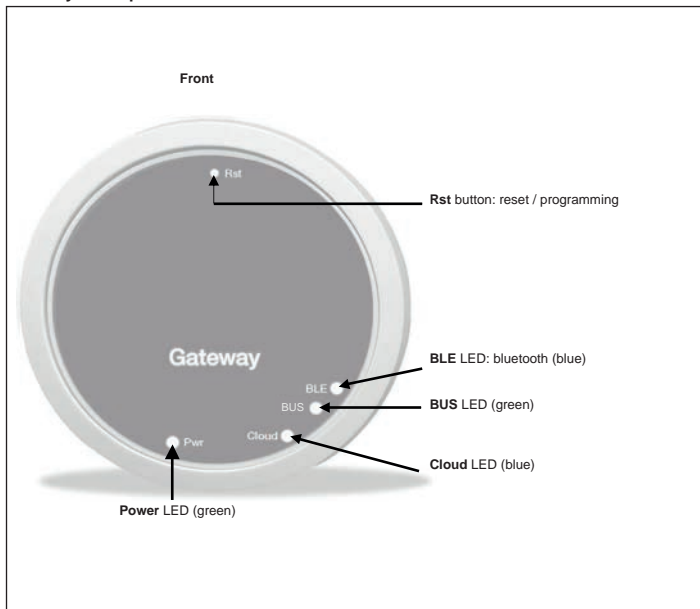

BUS connector to be connected to the boiler. Non-polarised connection

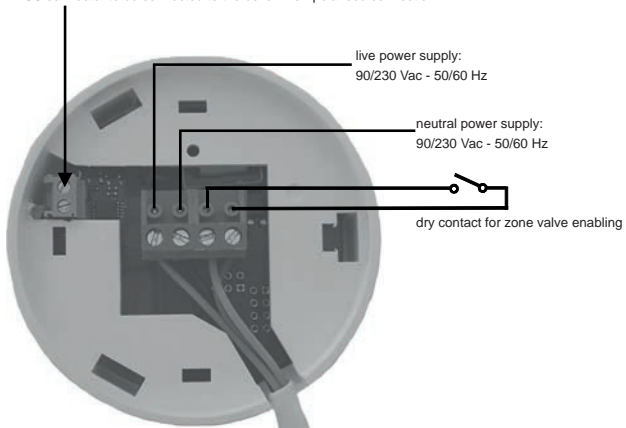

Back

## Gateway connection



**SAFETY WARNINGS:** The connection and installation of electrical appliances may only be carried out by professionally qualified personnel in accordance with the applicable national and safety regulations. Any intervention or modification to the appliance shall immediately terminate the warranty. For the connection of the 4-pole connector on the Gateway, see the picture above and the wiring diagrams described below. The connection between boiler and gateway is made between the 2-pole “BUS” terminals of the gateway and the boiler terminals for the “remote control” connection.

### *First connection*

Firstly, disconnect the power supply before carrying out any electrical and connection work on the boiler.

- Connect the power supply of the gateway so that it is in parallel with the boiler power supply downstream the same bipolar switch (**IT IS IMPORTANT THAT GATEWAY AND BOILER TURN ON AT THE SAME TIME**).
- Connect the dry open contact of the gateway to properly control the zone valve. Check the valve manual for the control diagram.
- Connect the communication port to the boiler terminals prepared for “remote control” connection; the two wires are not polarised.

Once the connections have been made, restore the mains voltage.



**WARNING:** the connection between gateway and boiler is indicated with the message “CON” on the boiler display (except for “Minorca/Nibir” - “Maiorca/Vega” - “Delfis/Ischia/Antea/Perl” - “Tenerife/Leo” boilers).

### **First Gateway Power On**

All Spot thermostats are already configured to work with the Gateway, so no additional configuration is required for operation.

In any case, below are some procedures to configure your Spot thermostat in total freedom and simplicity.



## Key of LEDs

The Gateway Spot is equipped with lights (LEDs) that signal the operation and the mode in which the gateway is operating; these LEDs can be on with a steady or blinking light depending on the status:

- **Power LED:** it signals the presence of voltage, the Gateway is on, it must always be steady on and green.
- **BLE LED:** it signals the bluetooth connection of the Gateway with Spot thermostats:
  - » **1 blink every 4 seconds:** it means that the Gateway is connected to Spot and is communicating regularly.
  - » **5 blinks per second:** it means that the Gateway is trying to connect to Spot, in case this blinking is frequent, try to bring the Gateway closer to Spot or vice versa.
- **BUS LED:** it signals the state of communication with the boiler:
  - » If the LED blinks once per second it means that the gateway does not communicate with the boiler
  - » If it blinks 5 times per second it means that it is communicating regularly with the boiler
- **Cloud LED:** it signals the connection to the home Wifi network and to the Spot cloud.
  - » **Off:** it means that the Gateway is not connected to any WiFi network or no account has been connected to this Gateway; Spot works regularly even without a WiFi connection, through the BLE connection.
  - » **1 blink per second:** it means that the Gateway is connecting to the WiFi network or to the associated account, if the blinking persists check that the WiFi network is active and verify that you have entered the correct password in the Gateway.
  - » **Steady on:** it means that the Gateway is connected to the WiFi network and the Cloud, and that it is working correctly.

## Connect the Gateway to a Wi-Fi network (account connection)



**WARNING:** Before performing this operation, make sure you have the password details of the WiFi network you want to connect to and be sure that this network has an internet connection.

If you want to control the Spot thermostat remotely, first download the “MYSPO” app from Google play store or Apple app store. Open the App, first create your account by following the App’s instructions and then register the gateway to your home Wi-Fi network.

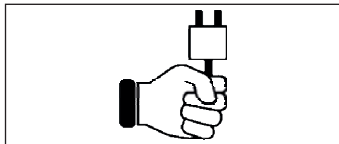

**Step 1**

Power up the Gateway, wait for a couple of minutes...



**Step 3**

The gateway will turn off and on again.



**Step 2**

Press the **Rst** button 5 times. The **Cloud** and **BLE** LEDs will light up together.

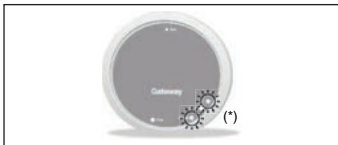

**Step 4**

When the two **Cloud** and **BLE** LEDs blink together once per second, the gateway is in Jot-to\_Config\_AP mode.

(\*) Blinking together

## Connect the Gateway to a Wi-Fi network (account connection)

### 1. Connection to a Wi-Fi network with ANDROID operating system

Open the App, log in, the message “No devices added yet” will appear, tap “+” and, after making sure that location is turned on on your smartphone, wait for the app to perform the “Retrieving current location” operation. Connect to the “JOTTO\_CONFIG\_AP” network via the Wi-Fi selection of your smartphone by entering the password 12345678.

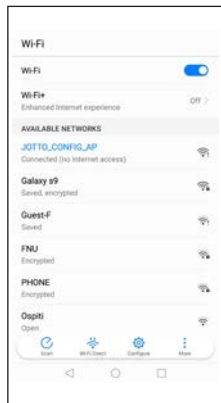
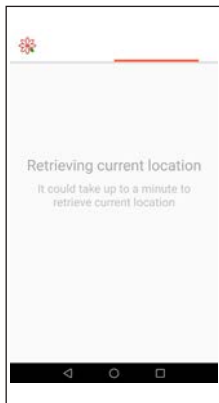
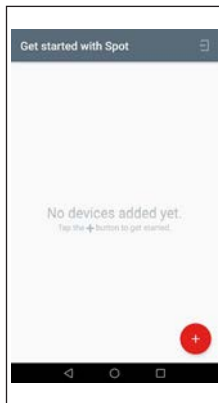

.....

Go back to the app and press "NEXT". Choose the Wi-Fi network to which you want to connect the Gateway and type the correct password. After connecting to the cloud, the message indicating the presence of a new Spot will appear. Type the name you want to give to your thermostat and press "SAVE DEVICE".

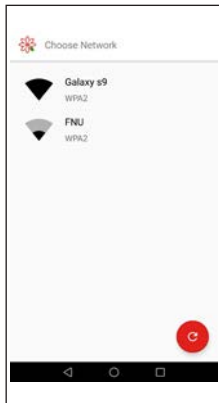

## Connect the Gateway to a Wi-Fi network (account connection)

### 2. Connection to a Wi-Fi network with IOS operating system

Open the App. Log in. Give the app permission to use your location. The message "Add a new device" will appear. Press the "+" button at the bottom right corner. Give the app permission to access the "JOTTO\_CONFIG\_AP" network by pressing the "Access" button. Press the "Wi-Fi search" button. Select the Wi-Fi network to which you want to connect the Gateway from the list and enter the password to access it. Wait for the procedure to be completed without closing the app. Then assign a name to the thermostat and confirm by pressing "OK". Wait for the message "Configuration completed successfully" to appear. Press "OK" to return to the main screen.



.....

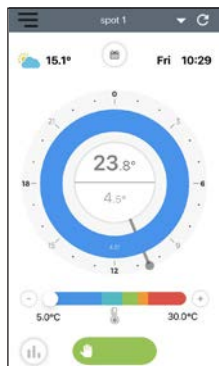
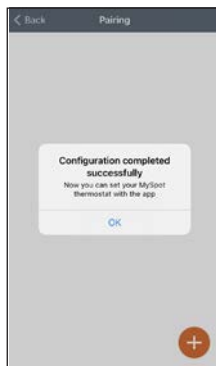
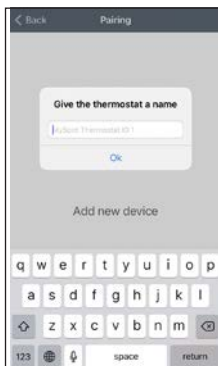
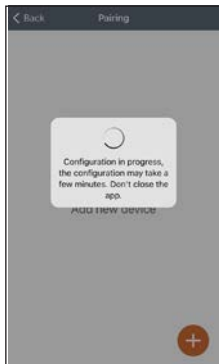

## How to modify the Gateway Wi-Fi network

If you have already connected the gateway to your account but you want to change the WiFi connection it is connected to, just follow the instructions below:



**WARNING:** Before performing this operation, make sure you have the password details of the WiFi network you want to connect to and be sure that this network has an internet connection.

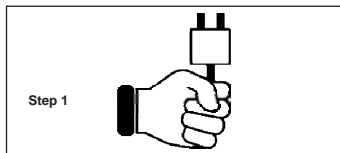

Power up the Gateway, wait for a couple of minutes...

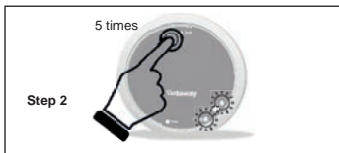

Press the **Rst** button 5 times. The **Cloud** and **BLE** LEDs will light up together and the gateway will turn off and on again.



The gateway will turn off and on again.

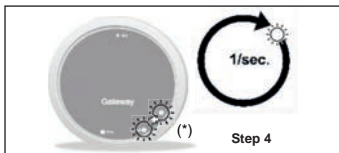

When the two **Cloud** and **BLE** LEDs blink together once per second, the gateway is in Jot-to\_Config\_AP mode.

(\*) Blinking together

## How to modify the Gateway Wi-Fi network

### 1. Connection to a Wi-Fi network with ANDROID operating system

From the App, select “Settings”, then “UPDATE” on “CONNECTED WI-FI NETWORK” and, after making sure that location is turned on on your smartphone, wait for the app to perform the “Retrieving current location” operation.

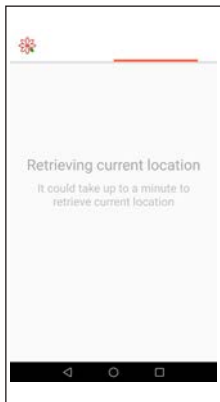
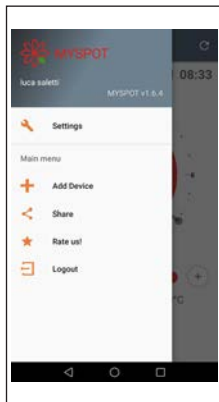



Connect to the "JOTTO\_CONFIG\_AP" network via the Wi-Fi selection of your smartphone by entering the password 12345678, go back to the app and press "NEXT". Choose the Wi-Fi network to which you want to connect the Gateway and type the correct password.

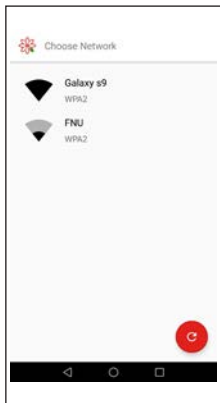

## How to modify the Gateway Wi-Fi network

### 2. Connection to a Wi-Fi network with IOS operating system

Open the menu at the top left corner of the main screen. Select the item "Settings". Press the "UPDATE" button which appears next to "CONNECTED WI-FI NETWORK". Give the app permission to access the "JOTTO\_CONFIG\_AP" network. Select the Wi-Fi network to which you want to connect the Gateway from the list and enter the password to access it. Wait for the procedure to be completed without closing the app. The app will show the message "Operation completed". Press the "Close" button. Press the "Back" button to return to the main screen.

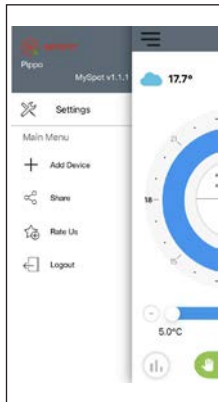

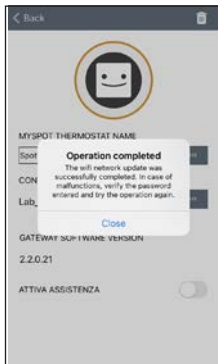

## Pairing second zone Spot WiFi Relay

Every **Spot Expansion** is equipped with modified WiFi sonoff relay to work with the Spot thermostat. For its correct operation, follow the procedure below for the configuration to the WiFi network to which the Gateway of the **Spot Starter Kit** is also connected. Connect the relay as shown in the figure below:



Connect to:

- 230Vac zone solenoid valve.
- Fondital zone kit.

Maximum current 10A at 230Vac



**The relay is modified according to Fondital's specifications, use only the relay of the Spot Expansion package. Fondital declines any responsibility for the use of a relay different from the one contained in the package.**



Press and hold the button for 10 seconds and then release, the LED will blink twice per second.

Take your smartphone and follow the instructions below:

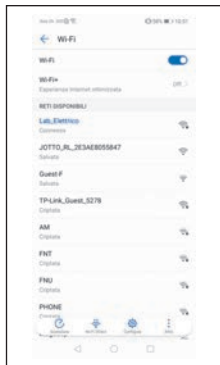

**Step 1**

Go to WiFi and select the network “JOTTO\_RL\_xxxx”, exit and open the browser and type the address “192.168.4.1”.



**Step 2**

The following relay page will open, click on “Configure wifi”.

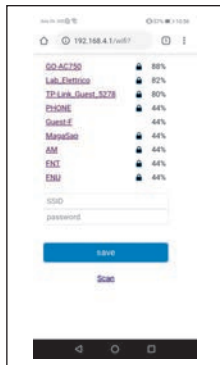

**Step 3**

The page shows the available WiFi networks, choose the network to which you have connected the Spot Gateway.



**Step 4**

Enter the password for the WiFi network to which the Spot Gateway is connected, and press enter.

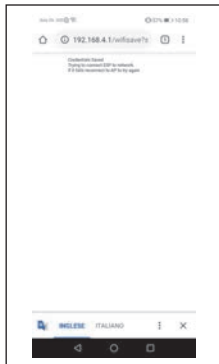

**Step 5**

If everything has been done correctly, the LED on the relay will stop blinking and will become steady; if this is not the case, repeat the procedure from the beginning.

## Pairing with a second zone Expansion on the same Gateway

### MEANING OF LED BLINKS DURING PAIRING

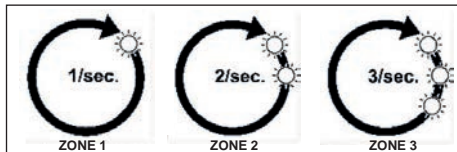

BLE LED: connection between gateway and spot.

Cloud LED: connection between gateway and relay.

Number of blinks per second: they indicate the zone.



**WARNING:** To add a second and/or third Spot Thermostat you must have a Wi-Fi router and an Internet connection. Up to three Spot thermostats can be paired to each Spot Gateway, so if you have purchased a “Spot Expansion”, follow the instructions below to pair your thermostats with the Gateway.

Make sure you have switched on the Gateway for at least 5 minutes



Press and hold the Rst button until you see the BLE LED switching from 5 fast blinks per second to one blink per second.



Click on the Rst button, the Cloud LED will blink once every second.

**Step 3**

Press the Rst button again, the BLE LED will blink fast twice every second; you are ready to pair the second Spot thermostat.

**Step 4**

Press on the Spot thermostat in the main screen for three seconds until the "SCHEDULE" menu is shown, then rotate it until "SETTING" appears, confirm, rotate again until "DIAGNOSTIC" is shown and confirm.

**Step 5**

Press on the Spot thermostat again, the messages "PAIRING" and then "CONNECTED" will appear. Wait until "DISCONNECTED" appears. Spot is now paired to the Gateway.

**Step 6**

Press for a few seconds on the Spot thermostat until returning to the main menu.



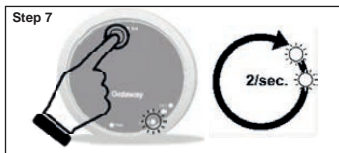

Press the **Rst** button again, the **Cloud** LED will blink fast twice every second; you are ready to pair the second Wi-Fi relay.

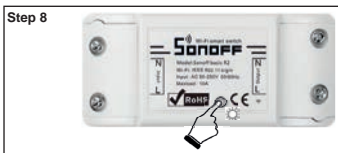

Now the relay is ready to be paired to the Gateway, fast click once on the relay button so that the relay is paired to the relevant Spot thermostat.

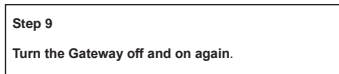

If the procedure has been correctly performed, the app will confirm the connection and ask you to type a name for the device.

After that, it will be possible to start controlling the system via the app.

### Pairing third zone Spot WiFi Relay

Every **Spot Expansion** is equipped with modified WiFi sonoff relay to work with the Spot thermostat. For its correct operation, follow the procedure below for the configuration to the WiFi network to which the Gateway of the **Spot Starter Kit** is also connected. Connect the relay as shown in the figure below:



Connect to:

- 230Vac zone solenoid valve.
- Fondital zone kit.

Maximum current 10A at 230Vac



The relay is modified according to Fondital's specifications, use only the relay of the Spot Expansion package. Fondital declines any responsibility for the use of a relay different from the one contained in the package.



Press and hold the button for 10 seconds and then release, the LED will blink twice per second.

Take your smartphone and follow the instructions below:

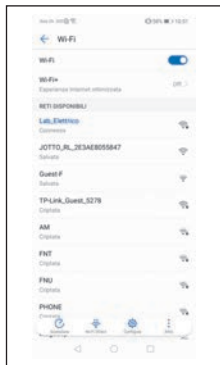

Step 1



Step 2

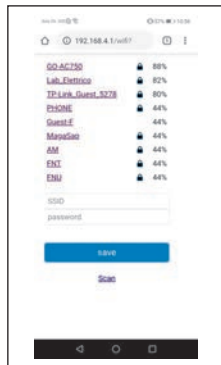

Step 3

Go to WiFi and select the network "JOTTO\_RL\_xxxx", exit and open the browser and type the address "192.168.4.1".

The following relay page will open, click on "Configure wifi".

The page shows the available WiFi networks, choose the network to which you have connected the Spot Gateway.



**Step 4**

Enter the password for the WiFi network to which the Spot Gateway is connected, and press enter.

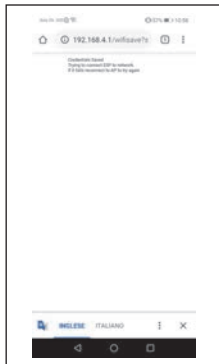

**Step 5**

If everything has been done correctly, the LED on the relay will stop blinking and will become steady; if this is not the case, repeat the procedure from the beginning.

## Pairing with a third zone Expansion on the same Gateway

### MEANING OF LED BLINKS DURING PAIRING

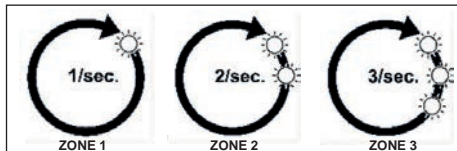

BLE LED: connection between gateway and spot.

Cloud LED: connection between gateway and relay.

Number of blinks per second: they indicate the zone.



**WARNING:** To add a second and/or third Spot Thermostat you must have a Wi-Fi router and an Internet connection. Up to three Spot thermostats can be paired to each Spot Gateway, so if you have purchased a "Spot Expansion", follow the instructions below to pair your thermostats with the Gateway.

Make sure you have switched on the Gateway for at least 5 minutes



Press and hold the Rst button until you see the BLE LED switching from 5 fast blinks per second to one blink per second.



Click on the Rst button, the Cloud LED will blink once every second.



Press the Rst button again, the BLE LED will blink fast twice every second; you are ready to pair the second Spot thermostat.



Click on the Rst button, the Cloud LED will blink twice every second.

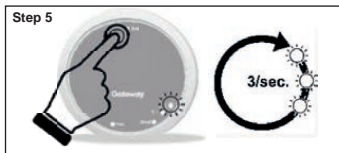

Press the Rst button again, the BLE LED will blink fast three times every second; you are ready to pair the third Spot thermostat.



Press on the Spot thermostat in the main screen for three seconds until the "SCHEDULE" menu is shown, then rotate it until "SETTING" appears, confirm, rotate again until "DIAGNOSTIC" is shown and confirm.

### Step 7



Press on the Spot thermostat again, the messages "PAIRING" and then "CONNECTED" will appear. Wait until "DISCONNECTED" appears. Spot is now paired to the Gateway.

### Step 8



Press for a few seconds on the Spot thermostat until returning to the main menu.

### Step 9



Press the **Rst** button again, the **Cloud** LED will blink fast three times every second; you are ready to pair the third Wi-Fi relay.

### Step 10



Now the relay is ready to be paired to the Gateway, fast click once on the relay button so that the relay is paired to the relevant Spot thermostat.

### Step 11

Turn the Gateway off and on again.

If the procedure has been correctly performed, the app will confirm the connection and ask you to type a name for the device.

After that, it will be possible to start controlling the system via the app.

## **Electrical connections (to be made by the installer)**

### ***Short functional description:***

Each thermostat regulates its own ambient temperature and boiler heating water supply temperature (see thermostat menu). The thermostat associated with zone 1 (master) is the only one that can set the boiler operating mode (WINTER - SUMMER - OFF) and adjust the domestic hot water temperature.

Each thermostat displays the current boiler status (heating or domestic hot water request), if the boiler burner is on, and the boiler and system alarms.

Through the Fondital App (Android - Apple) it is possible to remotely control your heating system with your smartphone. It is also possible to enable the Fondital technical service to remotely control all the heating system adjustment parameters.





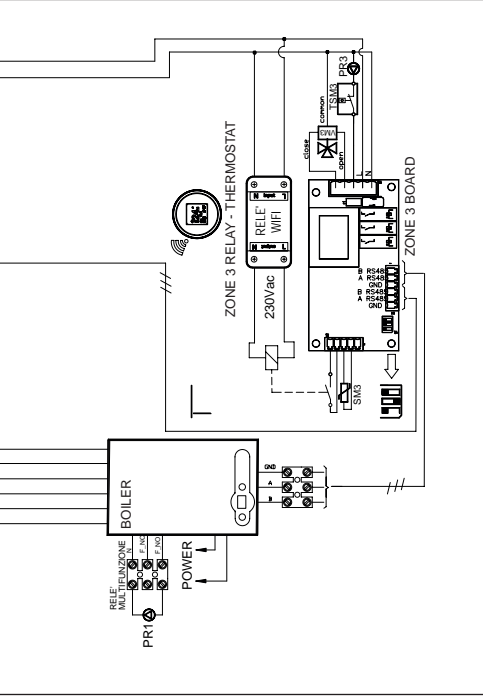

**ZONE1 AND ZONE3 THERMOSTATS:** it is mandatory to set the curves=0  
**BOILER**

- Set P60=2 (no. of present zones).
- Set P61=0.
- Set P10 (high temperature curve).
- Set zone 1 temperature with boiler heating button.
- Set P66 (zone 3 curve).
- Set P67 (zone 3 temperature).



## **Simplified EU Declaration of conformity**

The manufacturer **FONDITAL S.p.A.** declares that the type of radio equipment **Wi-Fi SPOT Thermoregulator starter kit, Wi-Fi SPOT Thermoregulator expansion kit** complies with Directive 2014/53/EU.

The full text of the EU Declaration of conformity is available at the following Internet address: [www.fondital.com](http://www.fondital.com)



0 L I B K I E N 7 6

Fondital S.p.A. - Società a unico socio  
25079 VOBARNO (Brescia) Italy - Via Cerreto, 40  
Tel. +39 0365 878 31  
Fax +39 0365 878 304  
e-mail: [info@fondital.it](mailto:info@fondital.it)  
[www.fondital.com](http://www.fondital.com)

The manufacturer reserves the right to modify his/her products as deemed necessary, without altering the basic characteristics of the products themselves.

Uff. Pubblicità Fondital IST 03 C 1349 - 03 | Giugno 2021 (06/2021)